







33 500 670



- 130mm projection
- fixed spout
- rectangular, air-enriched flow
- height of mixer 154 mm
- height up to aerator 80 mm
- hole diameter 35 mm
- 2x screw-in M 10 x 1 pressure hose, leak-tested
- max. flow 7 l/min
- lead-free
- This product can help a building meet the requirements of Green Building Rating Systems, e.g. LEED®, BREEAM®, DGNB

Only suitable for basins with an overflow.

	Chrome	33 500 670-00
	Brushed Platinum	33 500 670-06
	Platinum	33 500 670-08
	Brushed Durabronze (23kt Gold)	33 500 670-28
	Brushed Chrome	33 500 670-93
	Brushed Dark Platinum	33 500 670-99

33 500 670

mm [inches]

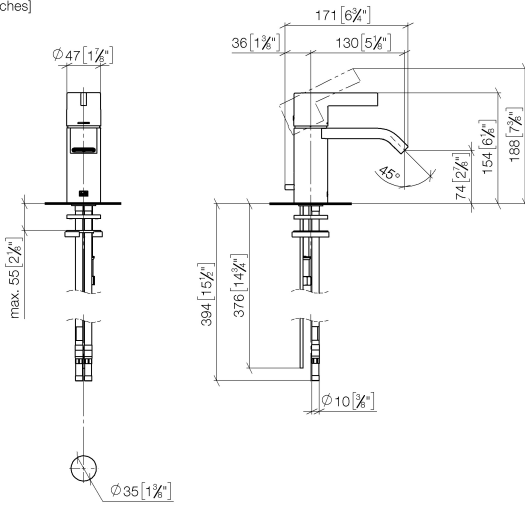

Flow rate chart



Certificates

WRAS_1806010. ETA_19965. LGA_19485. GDV_0400311. WRAS_240202005.

33 500 670

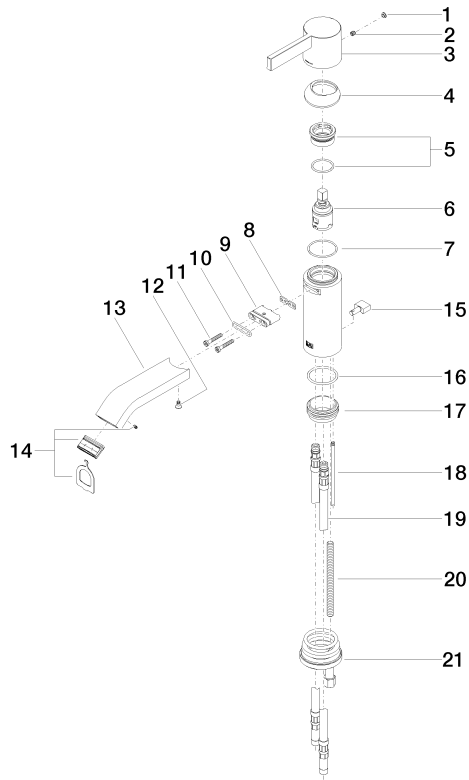

22 ———— Handygen für 14.11.01.201.00.0



IMO Single-lever basin mixer with pop-up waste - Chrome

IMO

33 500 670

Spare parts list

No.	Item Number	Name	Quantity used	Delivery time
1	90 31 20 087 00-00	plug	1	10
2	90 31 11 030 00 90	pin	1	2
3	09 20 67 003-00	handle	1	10
4	09 28 30 019-00	cover	1	10
5	90 23 10 066 00 90	nut	1	2
6	90 15 05 042 00 90	cartridge	1	2
7	09 14 10 102 90	seal	1	2
8	09 14 03 131 90	seal	1	2
9	09 11 03 061 90	connection	1	2
10	09 14 10 053 90	seal	1	2
11	09 30 30 084 90	screw	2	2
12	09 30 30 116 90	screw	1	2
13	09 28 22 239-00	spout	1	10
14	90 29 03 045 00 90	aerator	1	2
15	09 20 67 002-00	handle	1	10
16	09 14 10 119 90	seal	1	2
17	09 28 10 109-07	ring	1	30
18	09 31 09 080-00	pull-rod	1	10
19	04 30 04 016 00 90	hose	2	60
20	09 31 11 012 90	pin	1	2
21	04 30 11 085 88 90	fixing set	1	2
22	90 11 01 001 00-00	pop-up waste	1	10